

Article number: 20132224

Description: E+G Ball knob DIN 319-AL-50-B20-K

Measures

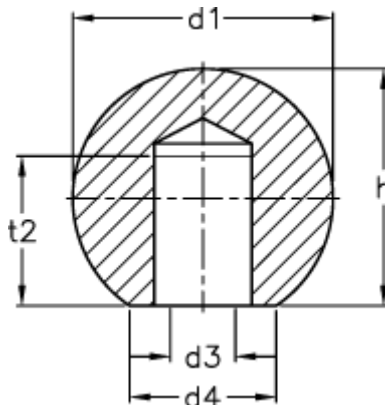

$d1$	= 50
$d3$ H7	= B20
$d4$	= 27
h	= 46.0
$t2$ min.	= 28